

DSO221SHF TYPE SPXO SPECIFICATION

1. Device Name SPXO
2. Type DSO221SHF
3. Frequency 16.000MHz
4. Absolute Maximum Value

	Item	Symbol	Rating	unit
1	Supply Voltage	V_{CC}	-0.6 ~ +6.0	V
2	Storage Temperature Range	T_{stg}	-40 ~ +85	°C

5. Recommended Operating Conditions

	Item	Symbol	min.	typ.	max.	unit
1	Supply Voltage	V_{CC}	+3.0	+3.3	+3.6	V
2	Operating Temperature Range	T_{opr}	-40	-	+85	°C
3	Output Load	L_{CMOS}	-	-	15	pF

6. Electrical Characteristics

($T_a=+25^{\circ}C$, $V_{CC}=+3.3V$ unless otherwise noted)

	Item	Symbol	Test Conditions	Limits			unit
				min.	typ.	max.	
1	Frequency Tolerance	f_{tol}	$V_{CC}=+3.3V \pm 0.3V$ $T_a=-40 \sim +85^{\circ}C$	-50	-	+50	ppm
2	Supply Current	I_{CC}	at No Load, #1pin:"H" or open	-	-	4.0	mA
	Standby Current	I_{std}	#1pin:"L"	-	-	0.005	mA
3	Output Character		15pF				
	3-1.Symmetry	SYM	0.5 V_{CC} level	45	50	55	%
	3-2.Rise Time	t_r	0.1 V_{CC} ~ 0.9 V_{CC}	-	-	5	ns
	3-3.Fall Time	t_f	0.9 V_{CC} ~ 0.1 V_{CC}	-	-	5	ns
	3-4.Low Level	V_{OL}		-	-	$V_{CC} \times 0.1$	V
	3-5.High Level	V_{OH}		$V_{CC} \times 0.9$	-	-	V
4	Input OE						
	4-1.Output enable time	t_{PZL}		-	-	1	ms
	4-2.Output disable time	t_{PLZ}		-	-	150	ns
	4-3.Enable input	V_{IH}		$V_{CC} \times 0.8$	-	-	V
	4-4.Disable input	V_{IL}		-	-	$V_{CC} \times 0.2$	V

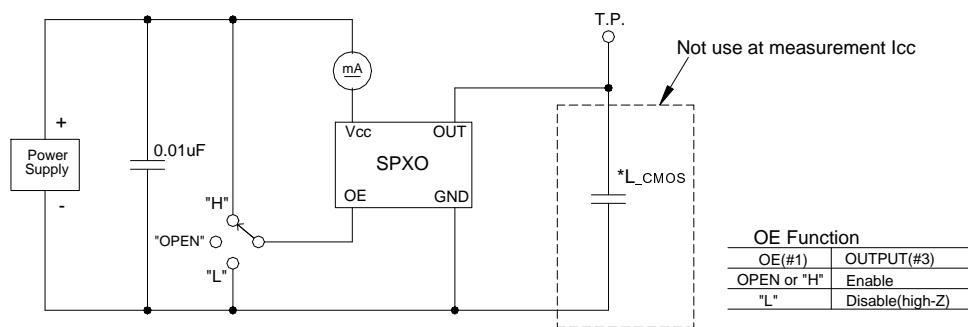

* L_{CMOS} :Total Fixture and Probe Capacitance

Fig1. Measurement Circuits

Date	Spec.No.	Rev.	Remark	Page.
2016/04/26	1XSF016000EH3	-	S16-047	1/2

DSO221SHF TYPE SPXO SPECIFICATION

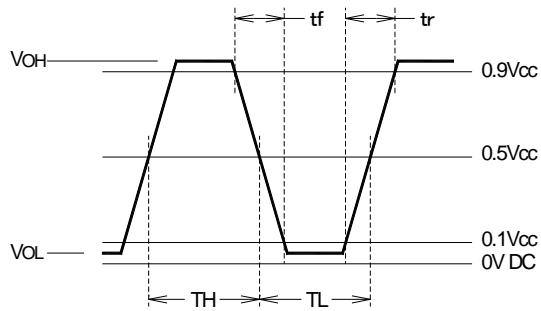

$$SYM = \frac{TH}{TL+TH} \times 100 (\%)$$

Fig2. Output Waveform

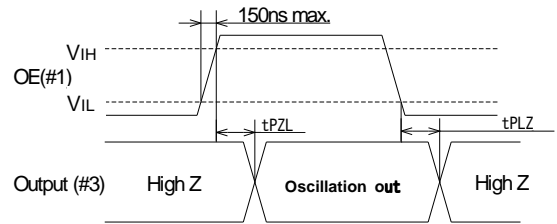
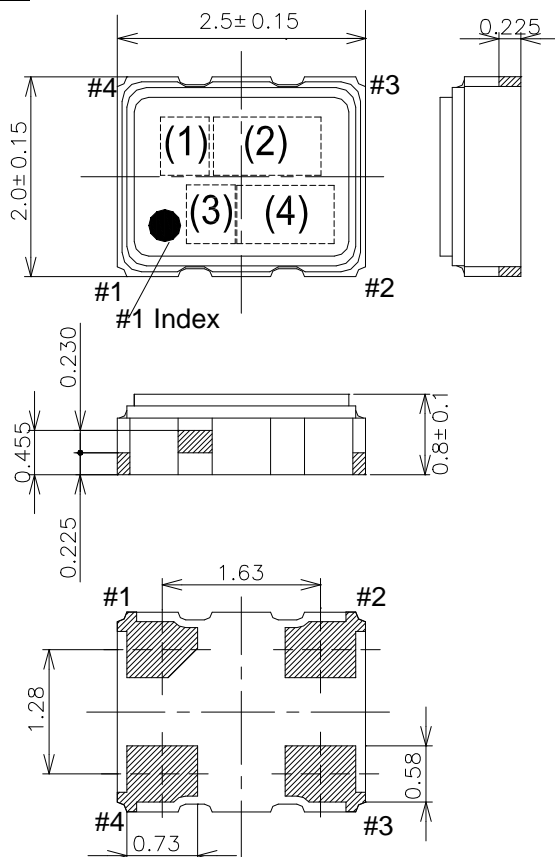

Fig3. Input output condition

7. Outline, Pin Connections

Outline



Pin Connections

Pin No.	Connection
#1	OE
#2	GND
#3	Output
#4	Vcc

Marking

- (1) Model Code HF
- (2) Frequency 16.0(MHz, 4digits)
- (3) Logo D
- (4) Lot No. Year(1digit)+Week(2digits)
e.g. 2016/01/01→601

unit: mm

Dimensional Tolerance: ±0.15

(Unless otherwise noted)

Land pattern layout(Example)

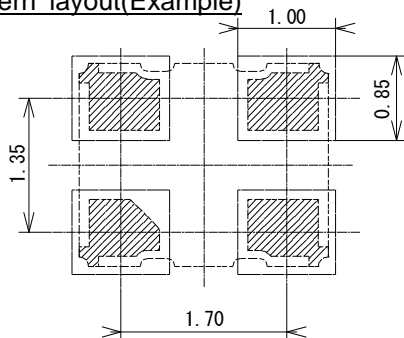

Date	Spec.No.	Rev.	Remark	Page.
2016/04/26	1XSF016000EH3	-	S16-047	2/2