

# DSO221SHF TYPE SPXO SPECIFICATION

1. Device Name                      SPXO
2. Type                                DSO221SHF
3. Frequency                        40.000MHz
4. Absolute Maximum Value

	Item	Symbol	Rating	unit
1	Supply Voltage	$V_{CC}$	-0.6 ~ +6.0	V
2	Storage Temperature Range	$T_{stg}$	-40 ~ +85	°C

5. Recommended Operating Conditions

	Item	Symbol	min.	typ.	max.	unit
1	Supply Voltage	$V_{CC}$	+3.0	+3.3	+3.6	V
2	Operating Temperature Range	$T_{opr}$	-40	-	+85	°C
3	Output Load	$L_{CMOS}$	-	-	15	pF

6. Electrical Characteristics

( $T_a=+25^{\circ}C$ ,  $V_{CC}=+3.3V$  unless otherwise noted)

	Item	Symbol	Test Conditions	Limits			unit
				min.	typ.	max.	
1	Frequency Tolerance	$f_{tol}$	$V_{CC}=+3.3V \pm 0.3V$ $T_a=-40 \sim +85^{\circ}C$	-50	-	+50	ppm
2	Supply Current	$I_{CC}$	at No Load, #1pin:"H" or open	-	-	4.0	mA
	Standby Current	$I_{std}$	#1pin:"L"	-	-	0.005	mA
3	Output Character		15pF				
	3-1.Symmetry	SYM	$0.5V_{CC}$ level	45	50	55	%
	3-2.Rise Time	$t_r$	$0.1V_{CC} \sim 0.9V_{CC}$	-	-	5	ns
	3-3.Fall Time	$t_f$	$0.9V_{CC} \sim 0.1V_{CC}$	-	-	5	ns
	3-4.Low Level	$V_{OL}$		-	-	$V_{CC} \times 0.1$	V
	3-5.High Level	$V_{OH}$		$V_{CC} \times 0.9$	-	-	V
4	Input OE						
	4-1.Output enable time	$t_{PZL}$		-	-	1	ms
	4-2.Output disable time	$t_{PLZ}$		-	-	150	ns
	4-3.Enable input	$V_{IH}$		$V_{CC} \times 0.8$	-	-	V
	4-4.Disable input	$V_{IL}$		-	-	$V_{CC} \times 0.2$	V

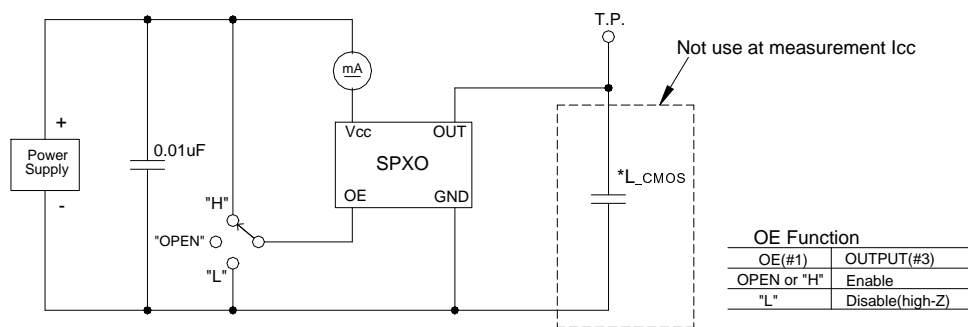

\* $L_{CMOS}$ :Total Fixture and Probe Capacitance

Fig1. Measurement Circuits

Date	Spec.No.	Rev.	Remark	Page.
2016/04/26	1XSF040000EH4	-	S16-053	1/2

# DSO221SHF TYPE SPXO SPECIFICATION

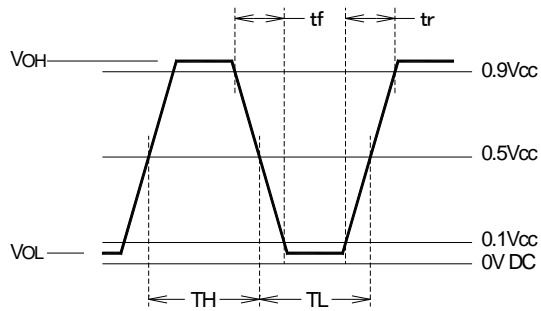

$$SYM = \frac{TH}{TL+TH} \times 100 (\%)$$

Fig2. Output Waveform

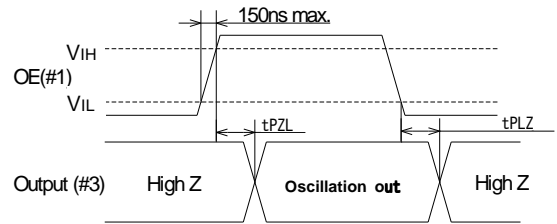
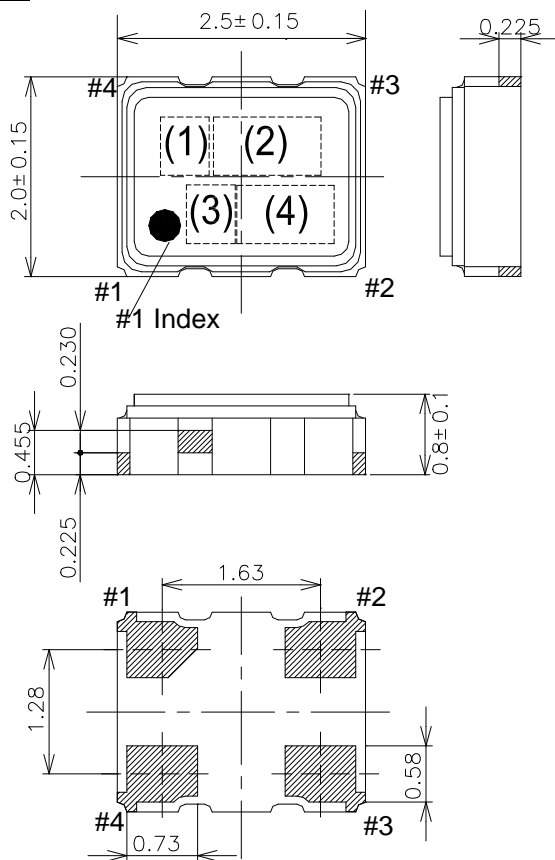

Fig3. Input output condition

## 7. Outline, Pin Connections

### Outline



### Pin Connections

Pin No.	Connection
#1	OE
#2	GND
#3	Output
#4	Vcc

### Marking

- (1) Model Code HF
- (2) Frequency 40.0(MHz, 4digits)
- (3) Logo D
- (4) Lot No. Year(1digit)+Week(2digits)  
e.g. 2016/01/01→601

unit: mm

Dimensional Tolerance: ±0.15

(Unless otherwise noted)

### Land pattern layout(Example)

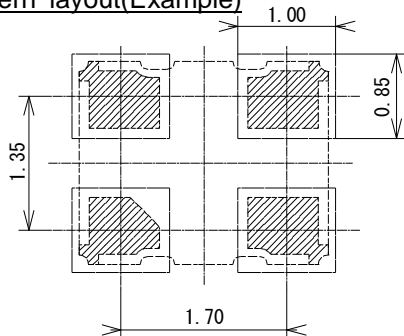

Date	Spec.No.	Rev.	Remark	Page.
2016/04/26	1XSF040000EH4	-	S16-053	2/2